

Panasonic®

Portable DVD/CD Player Operating Instructions

Model No. **DVD-LS5**
DVD-PS3



- This illustration shows DVD-LS5.
- DVD-PS3 does not have the LCD.

Region number

The player plays DVD-Video marked with labels containing the region number or "ALL".

Region	Number
For the United Kingdom and Continental Europe	2
For Asia	3
For Australia and N.Z.	4
For Russia	5

Example: For the United Kingdom and Continental Europe



Dear customer

Thank you for purchasing this product.

For optimum performance and safety, please read these instructions carefully.

Before connecting, operating or adjusting this product, please read these instructions completely. Please keep this manual for future reference.

Note

"EB" on the packaging indicates the United Kingdom.

EB EG GCS EE GN



RQT7074-3B

Caution for AC Mains Lead

(For United Kingdom) ("EB"area code model only)

For your safety, please read the following text carefully.

This appliance is supplied with a moulded three pin mains plug for your safety and convenience. A 5-ampere fuse is fitted in this plug. Should the fuse need to be replaced please ensure that the replacement fuse has a rating of 5-ampere and that it is approved by ASTA or BSI to BS1362.

Check for the ASTA mark  or the BSI mark  on the body of the fuse.

If the plug contains a removable fuse cover you must ensure that it is refitted when the fuse is replaced.

If you lose the fuse cover the plug must not be used until a replacement cover is obtained.

A replacement fuse cover can be purchased from your local dealer.

CAUTION!

IF THE FITTED MOULDED PLUG IS UNSUITABLE FOR THE SOCKET OUTLET IN YOUR HOME THEN THE FUSE SHOULD BE REMOVED AND THE PLUG CUT OFF AND DISPOSED OF SAFELY. THERE IS A DANGER OF SEVERE ELECTRICAL SHOCK IF THE CUT OFF PLUG IS INSERTED INTO ANY 13-AMPERE SOCKET.

If a new plug is to be fitted please observe the wiring code as stated below.

If in any doubt please consult a qualified electrician.

IMPORTANT

The wires in this mains lead are coloured in accordance with the following code:

Blue: Neutral, Brown: Live

As these colours may not correspond with the coloured markings identifying the terminals in your plug, proceed as follows:

The wire which is coloured Blue must be connected to the terminal which is marked with the letter N or coloured Black or Blue.

The wire which is coloured Brown must be connected to the terminal which is marked with the letter L or coloured Brown or Red.

WARNING: DO NOT CONNECT EITHER WIRE TO THE EARTH TERMINAL WHICH IS MARKED WITH THE LETTER E, BY THE EARTH SYMBOL  OR COLOURED GREEN OR GREEN/YELLOW.

THIS PLUG IS NOT WATERPROOF—KEEP DRY.

Before use

Remove the connector cover.

How to replace the fuse

The location of the fuse differ according to the type of AC mains plug (figures A and B). Confirm the AC mains plug fitted and follow the instructions below.

Illustrations may differ from actual AC mains plug.

1. Open the fuse cover with a screwdriver.

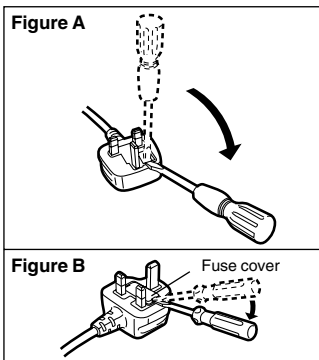

2. Replace the fuse and close or attach the fuse cover.

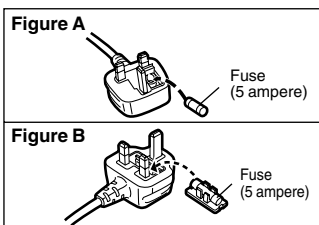

CAUTION!

THIS PRODUCT UTILIZES A LASER. USE OF CONTROLS OR ADJUSTMENTS OR PERFORMANCE OF PROCEDURES OTHER THAN THOSE SPECIFIED HEREIN MAY RESULT IN HAZARDOUS RADIATION EXPOSURE. DO NOT OPEN COVERS AND DO NOT REPAIR YOURSELF. REFER SERVICING TO QUALIFIED PERSONNEL.

WARNING:

TO REDUCE THE RISK OF FIRE, ELECTRIC SHOCK OR PRODUCT DAMAGE, DO NOT EXPOSE THIS APPARATUS TO RAIN, MOISTURE, DRIPPING OR SPLASHING AND THAT NO OBJECTS FILLED WITH LIQUIDS, SUCH AS VASES, SHALL BE PLACED ON THE APPARATUS.

CAUTION!

- DO NOT INSTALL OR PLACE THIS UNIT IN A BOOKCASE, BUILT-IN CABINET OR IN ANOTHER CONFINED SPACE. ENSURE THE UNIT IS WELL VENTILATED. TO PREVENT RISK OF ELECTRIC SHOCK OR FIRE HAZARD DUE TO OVERHEATING, ENSURE THAT CURTAINS AND ANY OTHER MATERIALS DO NOT OBSTRUCT THE VENTILATION VENTS.
- DO NOT OBSTRUCT THE UNIT'S VENTILATION OPENINGS WITH NEWSPAPERS, TABLECLOTHS, CURTAINS, AND SIMILAR ITEMS.
- DO NOT PLACE SOURCES OF NAKED FLAMES, SUCH AS LIGHTED CANDLES, ON THE UNIT.
- DISPOSE OF BATTERIES IN AN ENVIRONMENTALLY FRIENDLY MANNER.

The socket outlet shall be installed near the equipment and easily accessible or the mains plug or an appliance coupler shall remain readily operable.

Marking sign is located on bottom of the unit.

This product may receive radio interference caused by mobile telephones during use. If such interference is apparent, please increase separation between the product and the mobile telephone.

For the United Kingdom, Continental Europe, Russia, Australia and N.Z.

THIS UNIT IS INTENDED FOR USE IN

For Asia

THIS UNIT IS INTENDED FOR USE IN

NORSK

ADVARSEL!

DETTE PRODUKTET ANVENDER EN LASER. BETJENING AV KONTROLLER, JUSTERINGER ELLER ANDRE INNGREPP ENN DE SOM ER BESKREVET I DENNE BRUKSANVISNING, KAN FØRE TIL FARLIG BESTRÅLING. DEKSLER MÅ IKKE ÅPNES, OG FORSØK ALDRI Å REPARERE APPARATET PÅ EGENHÅND. ALT SERVICE OG REPARASJONSARBEID MÅ UTFØRES AV KVALIFISERT PERSONELL.

ADVARSEL:

FOR Å REDUSERE FAREN FOR BRANN, ELEKTRISK STØT ELLER SKADER PÅ PRODUKTET, MÅ DETTE APPARATET IKKE UTSETTES FOR REGN, FUKTIGHET, VANNDRÅPER ELLER VANNSPRUT. DET MÅ HELLER IKKE Plasseres GJENSTANDER FYLT MED VANN, SLIK SOM BLOMSTERVASER, OPPÅ APPARATET.

ADVARSEL!

- APPARATET MÅ IKKE Plasseres I EN BOKHYLLE, ET INNEBYGGET KABBINETT ELLER ET ANNET LUKKET STED HVOR VENTILASJONSFORHOLDENE ER UTILSTREKKELIGE. SØRG FOR AT GARDINER ELLER LIGNENDE IKKE FORVERRER VENTILASJONSFORHOLDENE, SÅ RISIKO FOR ELEKTRISK SJOKK ELLER BRANN FORÅRSAKET AV OVERHETING UNNGÅS.
- APPARATETS VENTILASJONSÅPNINGER MÅ IKKE DEKKES TIL MED AVISER, BORDDUKER, GARDINER OG LIGNENDE.
- Plasser IKKE ÅPEN ILD, SLIK SOM LEVENDE LYS, OPPÅ APPARATET.
- BRUKTE BATTERIER MÅ KASSERES UTEN FARE FOR MILJØET.

Utstyret bør plasseres i nærheten av AC-stikkkontakten, og støpslet må være lett tilgjengelig hvis det skulle oppstå problemer.

DETTE APPARATET ER BEREGNET TIL BRUK UNDER MODERATE KLIMAFORHOLD.

VAROITUS!

LAITTEEN KÄYTTÄMINEN MUULLA KUIN TÄSSÄ KÄYTTÖOHJEESSA MAINITULLA TAVALLA SAA TAAVA ALTI TASTAA KÄYTTÄJÄN TURVALLISUUSLUOKAN 1 YLITTÄVÄLLE NÄKYMÄTTÖMÄLLE LASERSÄTEILYLLE.

VAROITUS:

TULIPALO-, SÄHKÖISKUVAARAN TAI TUOTETTA KOHTAAVAN MUUN VAHINGON VÄHENTÄMISEKSI EI LAITETTA SAA ALTISTAA SATEELLE, KOSTEUDELLE, VESIPISAROILLE TAI ROISKEELLE, EIKÄ NESTETTÄ SISÄLTÄVIÄ ESINEITÄ, KUTEN ESIMERKIKSI MALJAKOITA, SAA ASETTAA LAITTEEN PÄÄLLE.

VAROITUS!

- ÄLÄ ASENNATA TAI LAITA TÄTÄ LAITETTA KABINETTITYYPPISEEN KIRJAKAAPPIIN TAI MUUHUN SULJETTUUN TILAAN, JOTTA TUULETUS ONNISTUISI. VARMISTA, ETTÄ VERHO TAI MIKÄÄN MUU MATERIAALI EI HUONONNA TUULETUSTA, JOTTA VÄLTETTÄISIIN YLIKUUMENEMISESTA JOHTUVA SÄHKÖISKU- TAI TULIPALOVAARA.
- ÄLÄ PEITÄ LAITTEEN TUULETUSAUKKOJA SANOMALEHDellä, PÖYTÄLIINALLA, VERHOLLA TAI MUULLA VASTAAVALLA ESINEELLÄ.
- ÄLÄ ASETA PALAVAA KYNTTILÄÄ TAI MUUTA AVOTULEN LÄHDETTÄ LAITTEEN PÄÄLLE.
- HÄVITÄ PARISTOT LUONTOA VAHINGOITTAMATTOMALLA TAVALLA.

Laite tulee asettaa lähelle verkkopistorasiaa ja pistokkeen täytyy olla sellaisessa asennossa, että siihen on helppo tarttua ongelman sattuessa.









TÄMÄ LAITE ON TARKOITETTU KÄYTETTÄVÄKSI LEUDOSSA ILMASTOSSA.

HighMAT™ and the HighMAT logo are either trademarks or registered trademarks of Microsoft Corporation in the United States and/or other countries.

**Accessories**

Please check and identify the supplied accessories. Use numbers indicated in parentheses when asking for replacement parts.

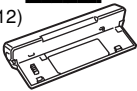

- Remote control** 1
(N2QAHC000012 or N2QAHC000019) 
- Button-type battery** 1
for remote control
(for replacement, → page 11) 
- Audio/video cable** 1
(K2KA6CB00003) 
- S video cable [DVD-PS3]** 1
(K2KC4CB00006) 
- AC adaptor** 1
For Australia and N.Z.
(DE-891CA)
For others
(DE-891AA-1) 
- AC mains lead** 1
For the United Kingdom
(RJA0053-3X)
For Australia and N.Z.
(RJA0035-K)
For others
(RJA0019-2X) 

- Rechargeable battery pack [DVD-LS5]** 1
(for replacement, → page 12) 

Note

The included AC mains lead and AC adaptor are for use with this unit only. Do not use them with other equipment.

The LCD [DVD-LS5]

Some of the LCD's pixels (less than 0.01 %) may light constantly or fail to light. This is normal and does not indicate a malfunction.

Table of contents

Getting Started

Caution for AC Mains Lead	2
Accessories	4
Precautions	6
Disc information	8
Control reference guide	10
The remote control	11
Adjusting the angle of the LCD DVD-LS5	11
Power supply	12
AC adaptor	12
Battery pack	12
Car adaptor	13
Using this unit with a television	14
Connection	14
Quick setup DVD-PS3	15
Selecting TV screen type	15

Getting Started

Basic Operations

Playing discs	16
Playing the programs or play lists on DVD-RAM	18
WMA/MP3, CD text and JPEG navigation menus	19
Playing HighMAT discs	21
Convenient features	22
Starting play from a selected program, title, track or picture	22
Playing only the audio—Audio Only Player DVD-PS3	22
Rotating pictures	22
Selecting groups to play	22
Changing the play sequence	23
Repeat play	24
A-B Repeat	24
Marker	25
Increasing your enjoyment of movies	25
Advanced Surround	25
Changing soundtracks, subtitle languages and angles	26

Advanced Operations

Changing the monitor settings DVD-LS5	27
Adjusting colour intensity	27
Adjusting the brightness	27
Changing the size of the picture	27
Using GUI screens	28
Common procedures	28
Progress indicator	28
Disc information	29
Unit information	30
Changing settings	31
Common procedures	31
Language code list	31
Using this unit with other equipment	34
Enjoying more powerful sound	34
Recording to digital recording equipment or cassette tapes	35

Reference

Glossary	35
Troubleshooting Guide	36
Maintenance	38
Specifications	39

Operations in these instructions are described mainly with the main unit, but you can do the operations on the remote control if the controls are the same (➡ page 10).

These operating instructions are applicable to models DVD-LS5 and DVD-PS3. Unless otherwise indicated, illustrations in these operating instructions are of DVD-LS5.

DVD-LS5 : indicate features available to DVD-LS5 only
DVD-PS3 : DVD-PS3 only

RQT0704

Precautions

Read these operating instructions carefully before using the unit. Follow the safety instructions on the unit and the applicable safety instructions listed below. Keep these operating instructions handy for future reference.

- 1) Read these instructions.
- 2) Keep these instructions.
- 3) Heed all warnings.
- 4) Follow all instructions.
- 5) Do not use this apparatus near water.
- 6) Clean only with dry cloth.
- 7) Do not block any ventilation openings. Install in accordance with the manufacturer's instructions.
- 8) Do not install near any heat sources such as radiators, heat registers, stoves, or other apparatus (including amplifiers) that produce heat.
- 9) Protect the AC mains lead from being walked on or pinched particularly at plugs, convenience receptacles, and the point where they exit from the apparatus.
- 10) Only use attachments/accessories specified by the manufacturer.
- 11) Use only with the cart, stand, tripod, bracket, or table specified by the manufacturer, or sold with the apparatus. When a cart is used, use caution when moving the cart/apparatus combination to avoid injury from tip-over.
- 12) Unplug this apparatus during lightning storms or when unused for long periods of time.
- 13) Refer all servicing to qualified service personnel. Servicing is required when the apparatus has been damaged in any way, such as AC mains lead or plug is damaged, liquid has been spilled or objects have fallen into the apparatus, the apparatus has been exposed to rain or moisture, does not operate normally, or has been dropped.



Batteries

1. **Battery pack (Lithium ion battery pack)**
 - Use this unit to recharge the battery pack.
 - Do not use the battery pack with equipment other than the specified player.
 - Do not use the player outside if it is snowing or raining. (The battery pack is not waterproof.)
 - Do not get dirt, sand, liquids, or other foreign matter on the terminals.
 - Do not touch the plug terminals (+ and -) with metal objects.
 - Do not disassemble, remodel, heat or throw into fire.
 - Do not store the battery pack in temperature over 60 °C.
2. **Button-type battery (Lithium battery)**
 - Insert with poles aligned.
 - Do not touch the terminals (+ and -) with metal objects.
 - Do not disassemble, remodel, heat or throw into fire.
 - Keep out of reach of children.

If any electrolyte should come into contact with your hands or clothes, wash it off thoroughly with water.

If any electrolyte should come into contact with your eyes, never rub the eyes. Rinse eyes thoroughly with water, and then consult a doctor.

3. Disposing of the batteries

Check and follow your local regulations before disposal.

CAUTION!
DANGER OF EXPLOSION IF BATTERY IS INCORRECTLY REPLACED.

REPLACE ONLY WITH THE SAME OR EQUIVALENT TYPE RECOMMENDED BY THE MANUFACTURER. DISCARD USED BATTERIES ACCORDING TO THE MANUFACTURER'S INSTRUCTIONS.

AC adaptor

This AC adaptor operates on AC between 100 V and 240 V.

But

- Obtain a suitable plug adaptor if the plug does not fit the AC mains socket.

To prevent damage

Avoid the following;

- Spraying flammable insecticides near the unit.
 - Pressing the LCD. **DVD-LSS**
 - Touching the lens and other parts of the laser pickup.
- Do not use the unit in the following places;
- Where the temperature is below 5 °C or above 35 °C. (Operating the unit beyond this range can cause the protection circuitry to function and render the unit inoperable.)
 - Sandy places such as beaches.
 - On top of cushions, sofas, or hot equipment such as amplifiers.

Precautions for Listening with the Headphones or Earphones

- Do not play your headphones or earphones at a high volume. Hearing experts advise against continuous extended play.
- If you experience a ringing in your ears, reduce volume or discontinue use.
- Do not use while operating a motorized vehicle. It may create a traffic hazard and is illegal in many areas.
- You should use extreme caution or temporarily discontinue use in potentially hazardous situations.
- Even if your headphones or earphones are the open-air type designed to let you hear outside sounds, don't turn up the volume so high that you can't hear what's around you.

Do not rest the unit on your lap for a long time while using it. The unit can become hot and cause burns.

For United Kingdom and Republic of Ireland

shop@ **Panasonic**

www.panasonic.co.uk (for UK customers only)

- Order accessory and consumable items for your product with ease and confidence by telephoning our Customer Care Centre Mon–Friday 9:00am–5:30pm. (Excluding public holidays.)
- Or go on line through our Internet Accessory ordering application.
- Most major credit and debit cards accepted.
- All enquiries transactions and distribution facilities are provided directly by Panasonic UK Ltd.
- It couldn't be simpler!

Customer Care Centre

For UK customers: 08705 357357
For Republic of Ireland customers: 01 289 8333

Technical Support

For UK customers: 0870 1 505610









This Technical Support Hot Line number is for Panasonic PC software related products only.

For Republic of Ireland, please use the Customer Care Centre number listed above for all enquiries.

For all other product related enquiries, please use the Customer Care Centre numbers listed above.

Disc information

Discs that can be played

DVD-RAM	DVD-Audio	DVD-Video	Video CD	CD	CD-R/RW
					—
					
RAM	DVD-A	DVD-V	VCD	CD	WMA MP3 JPEG

Use discs with the above logos and that conform to specifications. The unit cannot play other discs correctly.

Do not use irregularly shaped discs (e.g. heart-shaped), as these can damage the unit. It may not be possible to play CD-R, CD-RW, DVD-R and DVD-RAM in all cases due to the type of disc or condition of the recording.

Discs that cannot be played

DVD-ROM, CD-ROM, CDV, CD-G, +RW, DVD-RW, SACD, Divx Video Discs, Photo CD, DVD-RAM that cannot be removed from their cartridge, 2.6-GB and 5.2-GB DVD-RAM, and “Chaoyi VCD” available on the market including CVD, DVCD and SVCD that do not conform to IEC62107.

Built-in decoders



This unit can play discs with these symbols.

Video systems

This unit can play both the PAL and NTSC video systems. To view PAL or NTSC on your television however, your television must match the system used on the disc.

PAL discs cannot be correctly viewed on an NTSC television.

NTSC discs can be correctly viewed on a PAL television equipped to handle PAL 525/60 signals.

You can improve the quality of video from an NTSC disc when this unit is connected to an NTSC television by changing this unit's settings (➔ page 32, Video—NTSC Disc Output).

DVD-LS5

The LCD will lose colour when you select “NTSC”, but the picture on the television should be clearer.

Playing DVDs and Video CDs

The producer of these discs can control how they are played so you may not always be able to control play as described in these operating instructions (for example if the play time is not displayed or if a Video CD has menus). Read the disc's instructions carefully.

DVD-R discs

Panasonic DVD-R recorded and finalized on a Panasonic DVD video recorder or DVD video camera are played as DVD-Video on this unit.

DVD-RAM discs

The DVD-RAM you can play on this unit are those recorded with DVD video recorders, DVD video cameras, personal computers, etc. using Version 1.1 of the Video Recording Format (a unified video recording standard).

- Remove discs from their cartridges before use and return them when you are finished, making sure that the labels of the disc and cartridge face the same way.
- Some parts of the disc, for example where one program ends and another begins, may not play smoothly.

CD-R and CD-RW discs

This unit can play CD-R/RW (audio recording disc) recorded with CD-DA, video CD, SVCD (conforming to IEC62107), WMA, MP3, or JPEG. Close the session or finalize after recording.

See page 20 for more information about WMA, MP3, and JPEG.

HighMAT discs (➔ page 21)

Disc structure

Disc structure and the labels given to the items on discs depend on the disc type.

Track: the smallest division on DVD-Audio, CDs, and Video CDs, or a single WMA/MP3 file.

Chapter: the largest division on DVD-Video collections of tracks on DVD-Audio and equivalent to folders or albums on data discs.

Title: the largest division on DVD-Video, usually an entire movie.

Program: the division on DVD-RAM equivalent to a single recording.

Picture: a single JPEG file.

Play list: the largest grouping on a HighMAT disc, or a group of scenes on DVD-RAM.

Scene: DVD-RAM program sections specified and grouped into play lists on a DVD video recorder.

Content: covers tracks and pictures on HighMAT discs.

To clean discs

DVD-Audio, DVD-Video, Video CD, CD
Wipe with a damp cloth and then wipe dry.

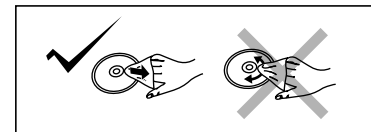

DVD-RAM, DVD-R

- Clean with an optional DVD-RAM/PD disc cleaner (LF-K200DCA1, where available).
- Never use cloths or cleaners for CDs, etc.

Handling precautions

- Do not write on the label side with a ball-point pen or other writing instrument.
- Do not use record cleaning sprays, benzine, thinner, static electricity prevention liquids or any other solvent.
- Do not attach labels or stickers to discs.
- Do not use discs with exposed adhesive from tape or left over peeled off stickers.
- Do not use scratch-proof protectors or covers.
- Do not use discs printed with label printers available on the market.

Control reference guide

Getting Started

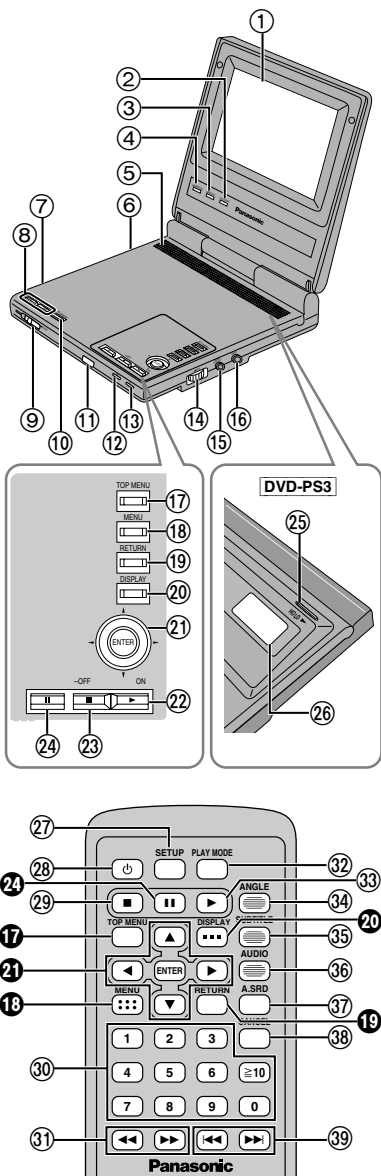

- ① **DVD-LS5** 5-inch wide screen LCD
- ② **DVD-LS5** Colour button (COLOUR) 27
- ③ **DVD-LS5** Bright button (BRIGHT) 27
- ④ **DVD-LS5** Monitor button (MONITOR) 27
- ⑤ **DVD-LS5** Monaural speaker
- ⑥ DC IN terminal (DC IN) 12
- ⑦ Headphone jack (Ω) 16
- ⑧ Skip/Slow/Search buttons (◀◀, ▶▶) 17
- ⑨ Disc lid switch (◀ OPEN) 16
- ⑩ Repeat button (REPEAT) 24
- ⑪ Remote control signal sensor
- ⑫ Charge indicator (CHG) 12
- ⑬ Standby indicator (Ⓞ) 12
- ⑭ Volume dial (◀ VOL) 16
- ⑮ Audio output, Optical digital output terminal (AUDIO/OPT OUT) 14, 34
- ⑯ Video output terminal (VIDEO) 14
- ⑰ Top menu button (TOP MENU) 17, 18
- ⑱ Menu button (MENU) 17, 18, 31
- ⑲ **DVD-LS5** Return button (RETURN) 17
- ⑲ **DVD-PS3** Return/Audio Only Player button (●RETURN/AOP) 17, 22
- ⑳ **DVD-LS5** Display button (DISPLAY) 13, 28
- ⑳ **DVD-PS3** Display/LCD mode button (●DISPLAY/LCD MODE) 13, 16, 28
- ㉑ Cursor jockey (▲, ▼, ◀, ▶)/ Enter button (ENTER) 15
Move the cursor jockey in the direction you want to move the cursor.
- ㉒ Play/On button (▶, ON) 16
- ㉓ Stop/Off button (■, - OFF) 17
- ㉔ Pause button (⏸) 17
- ㉕ **DVD-PS3** Hold switch (HOLD ▶) 16
- ㉖ **DVD-PS3** Display 16
- ㉗ Setup button (SETUP) 15
- ㉘ Standby/on switch (Ⓞ) 17
- ㉙ Stop button (■) 17
- ㉚ Numbered buttons (1-9, 0, ≧10) 17
- ㉛ Slow/Search buttons (◀◀, ▶▶) 17
- ㉜ Play mode button (PLAY MODE) 23
- ㉝ Play button (▶) 16
- ㉞ Angle button (ANGLE) 26
- ㉟ Subtitle button (SUBTITLE) 26
- ㊱ Audio button (AUDIO) 26
- ㊲ Advanced surround button (A.SRD) 25
- ㊳ Cancel button (CANCEL) 23
- ㊴ Skip buttons (◀◀, ▶▶) 17

Buttons such as ⑰ function the same as the controls on the unit.

The remote control

Battery (Lithium battery)

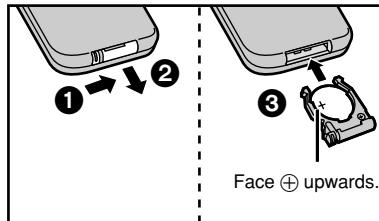

Replacement : CR2025

Use

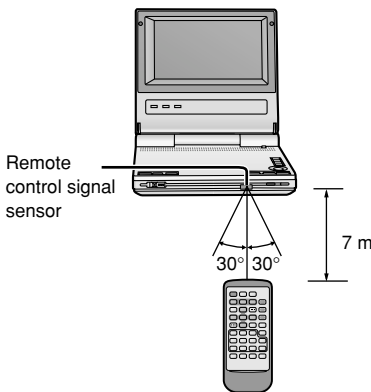

Aim at the sensor, avoiding obstacles, at a maximum range of 7 m directly in front of the unit.

Adjusting the angle of the LCD

DVD-LS5

Change the angle of the LCD to suit your viewing style.

Open the LCD

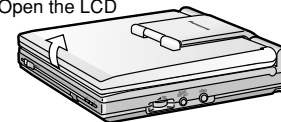

Traditional Viewing

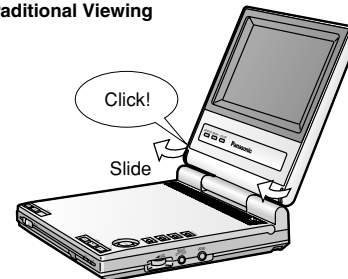

Enhanced Angle Viewing



Compact viewing



Note

Close the LCD when moving the unit. Do not carry by the LCD.

Getting Started

RQ17074

Power supply

AC adaptor

FOR THE UNITED KINGDOM ONLY
READ THE CAUTION FOR THE AC
MAINS LEAD ON PAGE 2 BEFORE
CONNECTION.

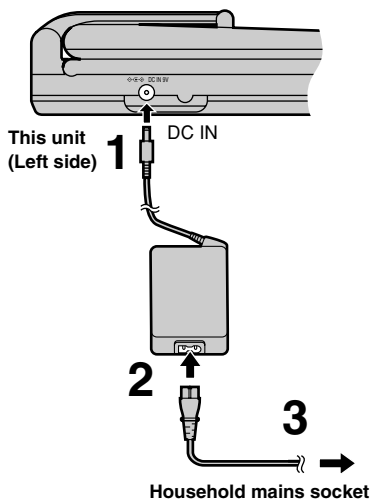

The unit is in the standby condition (the [⏻] indicator lights) when the AC mains lead is connected. The primary circuit is always "live" as long as the AC adaptor is connected to an electrical outlet.

When the unit is not going to be used for a long time

The unit consumes a small amount of power (approx. 0.9 W) when in standby mode. To conserve power, disconnect the AC mains lead from the mains socket.

Battery pack (Lithium ion battery pack)

Battery pack	DVD-LS5	DVD-PS3
CGR-H603	Included	Option
CGR-H601	Option	Option

- The illustrations show connection for the CGR-H603. Connect CGR-H601 in the same way.
- Charge the battery packs before using them for the first time.

To attach (When the unit is off)

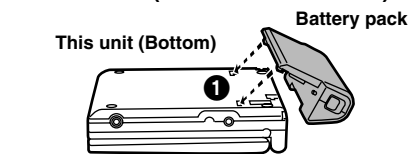

- Slide the pack so it clicks and locks into place.

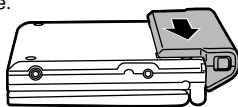

To recharge (When the unit is off)

Connect to the household mains socket while the battery pack is attached. (see left)

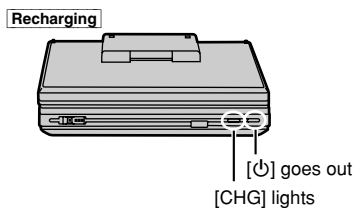

Recharging is complete when [CHG] goes out. ([⏻] lights.)
Disconnect the AC mains lead and AC adaptor.

To detach (When the unit is off)

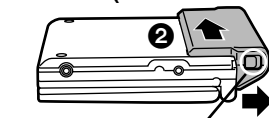

- Slide and hold the latch in position.

To confirm the battery charge

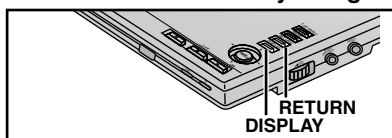

When the unit is on and powered by the battery pack

DVD-LS5 **DVD-PS3**
press [DISPLAY].

The battery indicator appears for a few seconds to show the approximate time remaining.

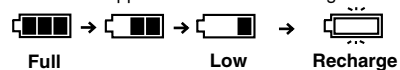

(Appears automatically when there is a few minutes of charge remaining.)

- Press [RETURN] to clear the GUI screens.

DVD-PS3
The battery indicator always appears on the unit's display.

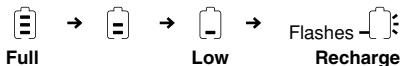

Recharging and play times

Times shown are approximate. Actual times depend on operating conditions.

Recharging (at 20 °C):

CGR-H603: 4 hours
CGR-H601: 6 hours

Play (in hours, at room temperature, using headphones):

Battery pack	LCD brightness level			LCD off
	- 5	0 (factory preset)	+ 5	
CGR-H603	2.5	2	1.5	3
CGR-H601	4.5	3.5	2.5	5.5

- To change the LCD brightness (→ page 27).

DVD-PS3

CGR-H603	3
CGR-H601	6

If the unit is not to be used for a long time

- Detach the battery pack. (Even if the unit is off, it still uses some power. This can drain the battery completely and lead to a malfunction.)
- Recharge the battery pack when you are ready to use it again.

Car adaptor (optional)

For the United Kingdom, Continental Europe, Russia, Australia and N.Z.

This unit (Left side)

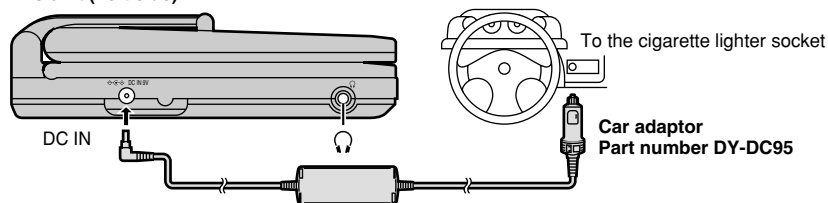

Note

- Read the car adaptor's operating instructions carefully.
- In the interests of the traffic safety, do not perform operations on the unit or watch video while driving a vehicle.
- You can enjoy sound through your car audio system by connecting a car stereo cassette adaptor (part number SH-CDM10A) to this unit's headphone jack (🎧).

Using this unit with a television

The explanations in this section use DVD-PS3 as an example, but the same connections and settings are possible with DVD-LSS. Before connecting, turn off all equipment and read the appropriate operating instructions. **Do not connect the player through your video cassette recorder.** The picture may not be played back correctly due to the copy guard.

Connection

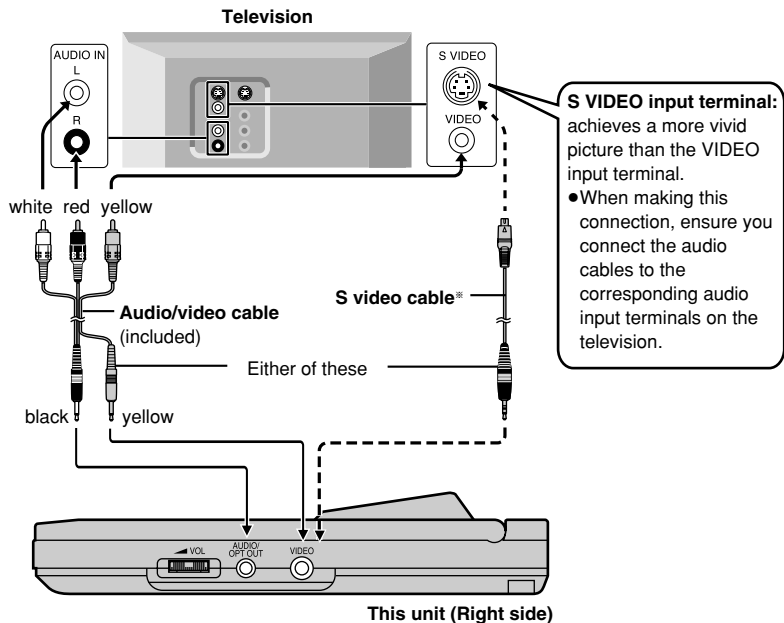

* **DVD-LSS:** S video cable is not included
Available from Panasonic dealers. Part number: **K2KC4CB00006**

For the United Kingdom and Continental Europe
Use the RCA adaptor (not included) if your TV has a 21-pin SCART terminal.

RCAJ adaptor (not included)

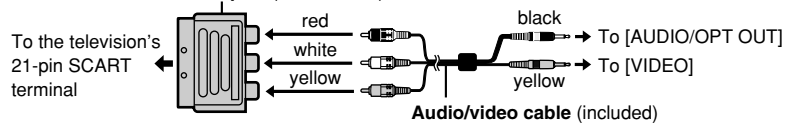

Note

- DVD-LSS** The unit's speaker does not have magnetic shielding. Do not place the unit near televisions, personal computers or other devices easily influenced by magnetism. Do not keep this unit and magnetized cards (bank cards, commuter passes, etc.) close together.
- Volume may be lower when playing DVDs than when playing other discs or during TV broadcasts. If you turn the volume up, reduce it again so that a sudden increase in output does not occur.

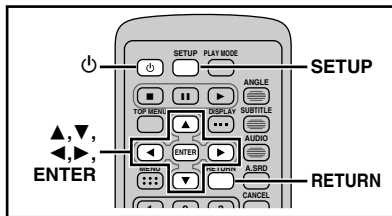

Preparations

Turn on your television and switch the video input mode on the television to suit the connection for the unit.

Quick setup DVD-PS3

The **QUICK SETUP** screen appears when you press [SETUP] the first time after purchase and assists you to make necessary settings.

- Press [POWER] to turn the unit on.
- Press [SETUP] to show the **QUICK SETUP** screen.
e.g. Units for the United Kingdom and Continental Europe

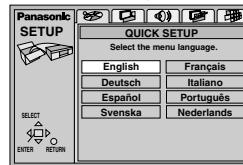

- Press [UP], [DOWN], [LEFT], [RIGHT] to select the menu language and press [ENTER].
- Press [UP], [DOWN] to select "Yes" to continue and press [ENTER].
- Press [UP], [DOWN], [LEFT], [RIGHT] to select the item and press [ENTER].
• Audio Language (→ page 32)
• Subtitle Language (→ page 32)
• TV Aspect (→ right)
- Press [ENTER] and then [SETUP] to end the settings.

To access this screen again later
→ page 33, Others—QUICK SETUP

Note

- To return to the previous screen
Press [RETURN].
- Press [MENU] on the main unit to access the SETUP menus when a disc is not loaded.

Selecting TV screen type

Select "4:3" (regular) or "16:9" (widescreen) to suit your television.

- Press [POWER] to turn the unit on.
- Press [SETUP] to show the menus.

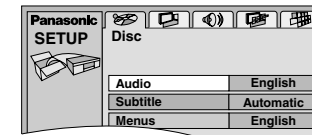

- Press [LEFT], [RIGHT] to select the "Video" tab.
- Press [UP], [DOWN] to select "TV Aspect" and press [ENTER].
- Press [UP], [DOWN] to select the item and press [ENTER].

•4:3 Pan & Scan

(DVD-PS3) : factory preset)

Widescreen software is expanded to fill the screen of a 4:3 aspect television (unless prohibited by the producer of the disc).



•4:3 Letterbox

Widescreen software is shown in the letterbox style on a 4:3 aspect television.



•16:9 (DVD-LSS) : factory preset)

Wide-screen television.

- Press [SETUP] to end the settings.

Playing discs

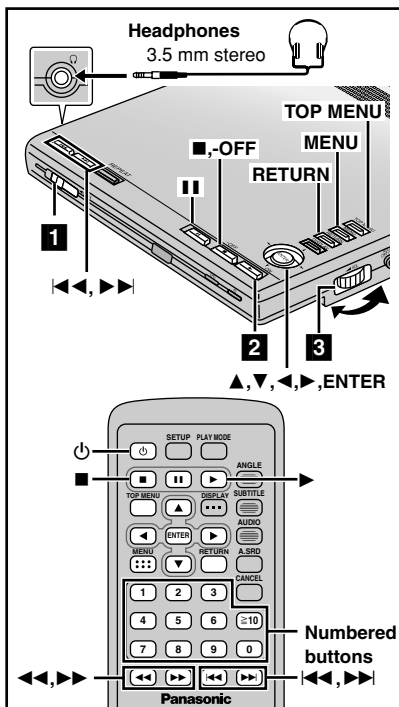

RAM DVD-A DVD-V VCD CD WMA MP3 JPEG

Preparations

- **DVD-LS5** Open the LCD (⇒ page 11).
- **RAM** Remove discs from their cartridges.

The menu language is set to English, but you can change it as follows (⇒ page 33, Display—Menu Language). English is used in the examples.

For the United Kingdom, Continental Europe, Russia, Australia and N.Z.

English→French/German/Italian/Spanish/Portuguese/Swedish/Dutch

For Asia English→French/Spanish

Note

- If “⊘” appears
The operation is prohibited by the unit or disc.
- Discs continue to rotate while menus are displayed even after playing an item. Press [■] when you finish to preserve the unit's motor.
- Play may not be possible when you hold the unit at different angles.

1 Slide [◀ OPEN] to open the disc lid and insert a disc.

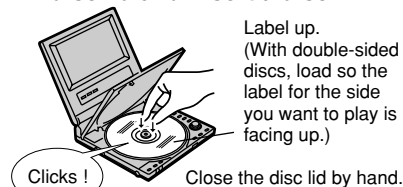

2 Press and hold [▶, ON] to start play.

The unit comes on automatically.

DVD-PS3

Play indicator

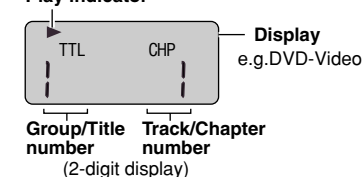

• **DVD-PS3**

Press and hold [●DISPLAY/LCD MODE] (⇒ page 10, ⊕) on the main unit to display the elapsed playing time.

• **If the disc contains both audio data (WMA and MP3) and JPEG**

Check “Mixed Disc-Audio & Stills” setting in the SETUP menu (⇒ page 33). Select “Stills (JPEG)” or “Audio (MP3/WMA)”, then open and close the lid so the unit reads the disc again.

• **CD WMA MP3 JPEG**

Disc information (⇒ page 29) and track information [WMA MP3 CD] (CD text only) appears.

3 Adjust the volume.

Using headphones

Turn down the volume before connection, and then adjust the level.

• **DVD-PS3** To prevent accidental operation

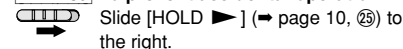

In the hold mode, the unit does not respond when you press the buttons. If you press a button in the hold mode, “HOLD” appears on the unit's display and the [⊕] indicator flashes.

To release

Slide [HOLD ▶] to the left.

Stop	Press [■]. “▷” flashes. Press [▶] (Play) to restart from this position (Resume function) or [■] to clear it. DVD-Video: Press [▶] (Play) again to review chapters (⇒ below).
Pause	Press [⏸]. DVD-PS3 e.g.DVD-Video Pause indicator appears on the main unit's display.
Skip	Press [◀◀] (backward) or [▶▶] (forward). Group skip [JPEG] Use [▼] (backward) or [▲] (forward).
Search	<Main unit> Press and hold [◀◀] (backward) or [▶▶] (forward). <Remote control> Press [◀◀] (backward) or [▶▶] (forward). Press [▶] (Play) to restart play. You can turn off the sound during search (⇒ page 33, Audio—Audio during Search).
Slow-motion	While paused <Main unit> Press and hold [◀◀] (backward) or [▶▶] (forward). <Remote control> Press [◀◀] (backward) or [▶▶] (forward). Press [▶] (Play) to restart play.
Frame-by-frame	While paused, use [◀] (backward) or [▶] (forward). Move and hold to change in succession. Or, press [⏸] repeatedly for forward frame-by-frame.
Menus	Use [▲, ▼, ◀, ▶] to select an item and [ENTER] to confirm. Or, press the numbered buttons. To return to the menu DVD-A Press [TOP MENU]. DVD-V Press [TOP MENU] or [MENU]. VCD Press [RETURN].

Notes

- The speed of search and slow-motion increases up to 5 steps.
- Slow-motion and frame-by-frame only work on moving pictures.
- **When playing Video CDs**
- You cannot move backwards during frame-by-frame and slow-motion.
- Pressing buttons to perform skip, search or slow-motion may take you to a menu screen.

Chapter Review **DVD-V**

The following message appears immediately after you press [▶] (Play).

Press PLAY to Chapter Review

(For Asia “Press PLAY to Preview Chapters”) Press [▶] (Play) while the message is displayed and the beginning portions of each chapter up to the current one are played. Full play resumes from the point where you stopped play. (This feature works only within a title.) If you do not press [▶] (Play), the message disappears and play starts from where you stopped it.

To turn the unit off

Press and hold [■, - OFF] until “OFF” appears.

Turning the unit on and off with the remote control

Press [⊕].

- You cannot use the remote control to turn the unit on when powered by the battery pack.

Auto standby function

The unit automatically turns off after being stopped for 15 minutes (5 minutes when the battery pack is being used).

Playing the programs or play lists on DVD-RAM

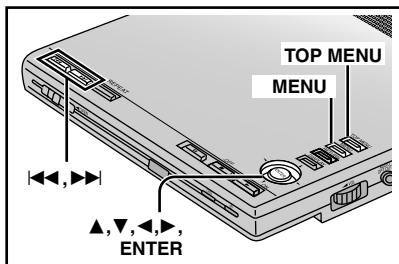

RAM

Selecting programs to play — DIRECT NAVIGATOR

1 Press [TOP MENU].

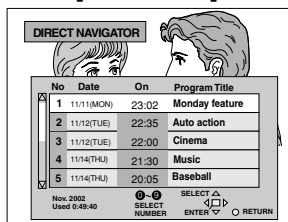

2 Use [▲, ▼] to select the program.

The selected program plays in the background.

3 Press [ENTER].

The program being played in the background continues.

Playing a play list

You can play a group of scenes, a play list, created on other equipment such as a DVD video recorder.

1 Press [MENU].

PLAYLIST	No	Date	Length	Title
1	10/17	0:46:35	Clay Penguin	
2	10/24	0:09:15	Ashley at Prom	
3	11/29	0:12:32	Formula one	
4	12/22	0:07:30	Soccer	
5	12/23	0:30:20	Baseball	
6	12/23	0:08:15	Neanderthal	
7	12/24	0:15:30	Cartoons	
8	12/24	0:20:30	Trilobites	
9	12/25	0:20:00	White Dwarf	
10	12/25	0:55:00	Discovery	

2 Use [▲, ▼] to select the play list.

3 Press [ENTER].

• To skip scenes, press [◀◀] or [▶▶].

• You can also select items with the remote control's numbered buttons.

Select an item to start play

Programs and play lists: Press the numbered buttons.

To select a two-digit number:
e.g. "25": [≥10]→[2]→[5]

To clear the list

DIRECT NAVIGATOR: Press [TOP MENU].

Play list: Press [MENU].

(The unit returns to the condition it was in before you called up the list.)

Note

- Titles appear only if you have entered them.
- You cannot change titles.

WMA/MP3, CD text and JPEG navigation menus

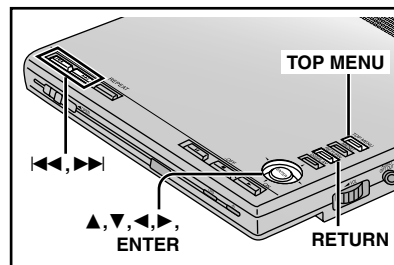

WMA MP3 CD (CD text only) JPEG

If the disc contains both audio data (WMA and MP3) and JPEG

Check "Mixed Disc-Audio & Stills" setting in the SETUP menu (→ page 33). Select "Stills (JPEG)" or "Audio (MP3/WMA)", then open and close the lid so the unit reads the disc again.

1 Press [TOP MENU].

WMA/MP3 Audio navigation menu

MENU	No	Group	001 My Favorite Tree
G 1	1	001	Both Ends Freezing
T 1	2	002	Lady Starfish
Total 1	3	003	Life on Jupiter
	4	004	Metal Glue
	5	005	Paint It Yellow
	6	006	Pyjamaama
	7	007	Shrimps from Mars
	8	008	Starperson
	9	009	Velvet Cuppermine
	10	010	Ziggy Starfish

JPEG Album display

JPEG ALBUM	Group: 001 Penguins	Picture: filename00...
G 1	1	
P 1	1	
Total 1	1	

2 Use [▲, ▼] to select the track or [▲, ▼, ◀, ▶] to select the picture, and press [ENTER].

To show other pages, use [▲, ▼, ◀, ▶] to select "Prev" or "Next" and press [ENTER].

• "☞" indicates the track currently playing.

To exit the menu

Press [TOP MENU].

Track title search

WMA MP3 CD (CD text only)

Example: finding a track including the word "LOVE".

1 While the menu is displayed Use [▲, ▼] to select "Find" and press [ENTER].

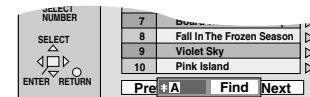

2 Use [▲, ▼] to select "L" and press [ENTER].

Only uppercase appear but the search also includes lower case. Characters change in alphanumeric order each time you press [▲].

• Press [◀◀, ▶▶] to skip between A, E, I, O and U.

• Use [◀] to erase a character.

• You can enter numbers with the numbered buttons.

• You can erase the asterisk (*) to search for the first word in a title.

Repeat this step to enter "O", "V", and "E".

3 Use [▶] to select "Find" and press [ENTER].

The search results screen appears.

4 Use [▲, ▼] to select the track and press [ENTER].

To return to the menu

Press [RETURN].

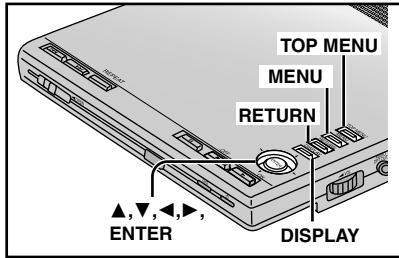

To use the contents screen to find a track [CD] (CD text only)

You can use the text information recorded on these discs to find a track to play.

- 1 While the menu is displayed Use [▶] while a track is highlighted to display the contents screen.

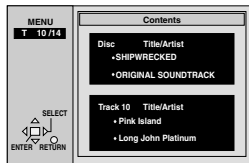

- 2 Use [◀, ▶] to move through the tracks and press [ENTER].

To use the tree screen to find a group [WMA] [MP3] [JPEG]

- 1 While the menu is displayed Use [▶] while a track is highlighted to display a tree screen.

Use [▲, ▼, ◀, ▶] to select "Tree" and press [ENTER].



You cannot select groups that contain no compatible files.

- 2 Use [▲, ▼] to select a group and press [ENTER].

The audio navigation menu/album display for the group appears.

To return to the menu
Press [RETURN].

Note

WMA

- You cannot play WMA files that are copy protected.
- WMA files must have the extension ".WMA" or ".wma".

MP3

- This unit is not compatible with ID3 tags.
- If you play an MP3 track that includes still picture data, it will take some time before the music itself starts playing and the elapsed time will not be displayed during this time. Even after the track starts, the correct play time will not be displayed.
- MP3 files must have the extension ".MP3" or ".mp3".

JPEG

- To view JPEG files on this unit:
 - Take them on a digital camera that meets the DCF (Design rule for Camera File system) standard. Some digital cameras have functions that are not supported by the DCF standard like automatic picture rotation which may render a picture un-viewable.
 - Do not alter the files in any way or save them under a different name.
 - Ensure they have the extension ".JPG", ".jpg", ".JPEG", or ".jpeg".

- This unit cannot display moving pictures, MOTION JPEG and other such formats, still pictures other than JPEG (e.g. TIFF) or play associated sound.

WMA [MP3] [JPEG]

- Discs must conform to ISO9660 level 1 or 2 (except for extended formats).
- This unit is compatible with multi-session but if there are a lot of sessions it takes more time for play to start. Keep the number of sessions to a minimum to avoid this.

Naming folders and files

At the time of recording, prefix folder and file names with 3-digit numbers in the order you want to play them (this may not work at times).

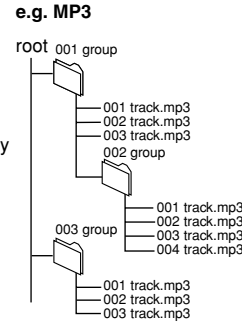

Windows Media, and the Windows logo are trademarks, or registered trademarks of Microsoft Corporation in the United States and/or other countries.

WMA is a compression format developed by Microsoft Corporation. It achieves the same sound quality as MP3 with a file size that is smaller than that of MP3.



Playing HighMAT discs

HighMAT (High performance Media Access Technology) is a new standard for storing audio, image, and video data files on CD media. When you create a HighMAT CD using compliant PC software, you can make playlist settings and also record text information such as titles and artist names. File searching is made easy using CDs recorded in HighMAT through use of a versatile navigation system. CDs recorded in HighMAT can also be played on your PC.

This unit is compatible with HighMAT discs containing WMA, MP3, or JPEG data. There are some differences from other WMA/MP3/JPEG discs.

A menu appears after you insert the disc.

- Use [▲, ▼, ◀, ▶] to select then press [ENTER].

When you press [ENTER]:

- Menu: Takes you to the next menu which shows play lists or another menu
- Play list: Play starts

- To return to the menu screen Press [TOP MENU].
- To return to the menu above the current one Press [RETURN].
- To change the menu background Press [DISPLAY].
The background changes to the one recorded on the disc.

Selecting from the lists

- 1 While playing Press [MENU].

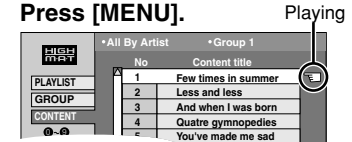

- 2 Use [◀] then [▲, ▼] to switch between the play list, group and content lists.

- 3 Use [▶] then [▲, ▼] to select an item and press [ENTER].

- To exit the list screen Press [MENU].

Note

Disable HighMAT disc play to use random and program play.

- To use program/random play In the SETUP menu, set "HighMAT" to "Disable" (→ page 33).

Convenient features

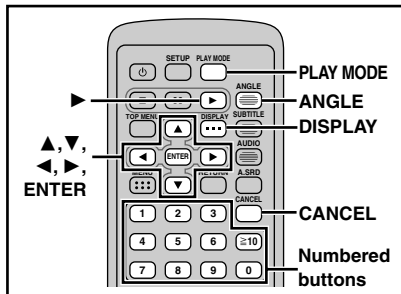

Starting play from a selected program, title, track or picture

RAM DVD-A DVD-V VCD CD WMA MP3 JPEG

Remote control only

Press the numbered buttons to select the item (WMA MP3 JPEG and press [ENTER]).

Play starts from the selected item.

To select a 2-digit number

e.g. 25: [2] → [5]

WMA MP3 JPEG

[2] → [5] → [ENTER]

If a GUI screen appears (→ page 28)

- This works only when stopped with some discs.
- When playing DVD-Audio and you want to start play from a track in a different group, select the group first (→ right).

Playing only the audio

—Audio Only Player DVD-PS3

DVD-A

Main unit only

You can enjoy higher quality audio by stopping the video signal.

While stopped

[the resume function (→ page 17) is not activated]

Press and hold [•RETURN/—AOP].

(→ page 10, 19)



- Audio Only Player is canceled if you press and hold the button again while the resume function is not activated, or if you turn the unit off.
- You may not be able to play parts that include moving pictures.

Rotating pictures

JPEG

Remote control only

While a picture is displayed

- 1 Press [ANGLE].
- 2 Use [▲, ▼] to select “Rotate right” or “Rotate left” and press [ENTER].

The picture rotates ninety degrees each time you do this.

- The rotation is canceled when you open the disc lid, or switch the unit to standby.

To clear the popup screen

Press [ANGLE].

Selecting groups to play

DVD-A WMA MP3 JPEG

- 1 Press [DISPLAY] to show Disc information.

e.g. MP3

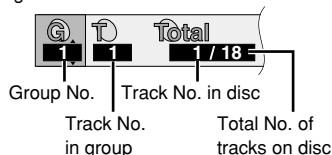

- 2 Use [▲, ▼] to select the group number and press [ENTER].

- 3 Use [▲, ▼] to select the track/picture number and press [ENTER].

- You can also select the group and track/picture number with the numbered buttons.

DVD-A

- Playing all the groups in succession

(→ page 23, All group play)

- Playing a bonus group

Some discs contain a bonus group. If a password screen appears after selecting a group, enter the password with the numbered buttons. Refer also to the disc's jacket.

Changing the play sequence

DVD-A DVD-V VCD CD WMA MP3

Remote control only

While stopped

Press [PLAY MODE].

The indicator changes each time you press the button.

A All group (DVD-A) → B Program
← OFF ← C Random ←

A All group play

DVD-A

The unit plays tracks in all the groups on a disc.

Press [▶] (Play).

DVD-PS3

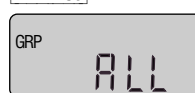

B Program play

You can select up to 32 items to play in the order you choose.

1

DVD-A DVD-V WMA MP3

Press the numbered buttons to select a group or a title.

e.g. DVD-Video

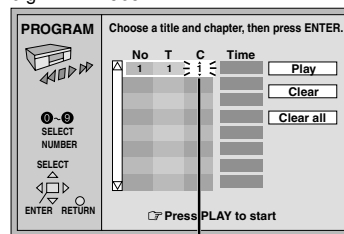

Flashes

DVD-PS3 e.g. DVD-Video

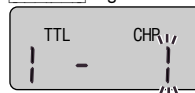

Flashes

- DVD-V Some items cannot be selected.
- DVD-A If you select a bonus group, you will have to enter a 4-digit password.

To exit the all group/program/random mode

Press [PLAY MODE] while stopped until the all group/program/random play screen disappears.

- 2 Press the numbered buttons to select a track or a chapter (WMA MP3 and press [ENTER]).

- Repeat steps 1 and 2 to program other items.

- Times are not displayed when programming DVD-Video and WMA/MP3.

DVD-PS3 e.g. DVD-Video



- 3 Press [▶] (Play).

- DVD-V Some items cannot be played even if you programmed them.

To add, change, or clear items

- 1 Use [▲, ▼] to select the program number (No).
- 2 Do steps 1 and 2 to add or change items. Press [CANCEL] to clear an item (or use [▲, ▼, ◀, ▶] to select “Clear” and press [ENTER]).

To clear the whole program

Move to “Clear all” with [▲, ▼, ◀, ▶] and press [ENTER]. The whole program is also cleared when you open the disc lid or switch the unit to standby.

To select an item using the cursor jockey

Press [ENTER] and [▲, ▼] to select an item, then press [ENTER] again to register the number. All the items on a disc, a title or a group are selected when you select “ALL”.

C Random play

1

DVD-A DVD-V

Press the numbered buttons to select a group or a title.

e.g. DVD-Video



DVD-A

- You can select more than one group.

To enter all groups, select “All” using [◀, ▶] and press [ENTER].

- To deselect a group, press the numbered buttons corresponding to the group you want to clear.

- If you select bonus groups, you will have to enter a 4-digit password.

- 2 Press [▶] (Play).

- DVD-V Some titles cannot be selected.

Convenient features

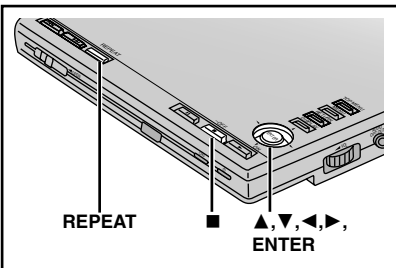

Repeat play

Main unit only

RAM DVD-A DVD-V VCD CD WMA MP3 JPEG

During play

Press [REPEAT].

e.g. DVD-Video

Each time you press the button:



RAM
Program → All → Off

During play list play
Scene → Play list → Off

DVD-A WMA MP3
Track → Group* → Off

DVD-V
Chapter → Title* → Off

VCD CD
Track → All → Off

JPEG
Group → Off

* "All" during all group, program and random play.

• You can also repeat play of "Content" and "Group" on HighMAT discs.

• **DVD-PS3**
The repeat indicator on the unit's display is the same as the mode change sequence indicated above.

RAM DVD-A DVD-V VCD CD WMA MP3

1 → Off

JPEG
→ Off

If the Video CD has playback control

1. Press [■].
2. Press the numbered buttons on the remote control selecting an item to start play (→ page 22).
3. Select the repeat mode (→ left).

Note

- This only works if the disc's elapsed play time is shown (→ page 29).
- You cannot use repeat play to repeat an entire DVD-Video, an entire WMA/MP3/JPEG disc or all the play lists on a DVD-RAM.

■ To repeat only your favorite tracks/chapters

DVD-A DVD-V VCD CD WMA MP3

Start program play (→ page 23) and select "All" (→ left).

A-B Repeat

RAM DVD-A DVD-V VCD CD WMA MP3

You can repeat a section between point A and point B within an item.

During play

1 Do steps 1 to 3 on page 28 to select "A-B Repeat".



A-B Repeat

2 Press [ENTER] to specify start point A and end point B.

Each time you press the button

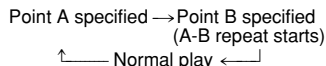

DVD-PS3

The A-B Repeat indicator on the unit's display is the same as the mode change sequence indicated above.

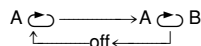

Note

- This feature works only within a program/track/title.
- The unit automatically determines the end of a program/track/title as point B when the end of the program/track/title is reached.
- Subtitles around point A or B may fail to appear.

Marker

RAM DVD-A DVD-V VCD CD WMA MP3 JPEG

You can mark up to 5 positions to play again.

RAM: 999 positions

If places have been marked (e.g., with a DVD video recorder), they are displayed.

1 Do steps 1 to 3 on page 28 to select "Marker".



Marker

2 Press [ENTER].

RAM Use [▶] to select "*".



The unit is now ready to accept markers.

3 Press [ENTER] to mark a position.

To recall a marker: [◀, ▶] → [ENTER]

To erase a marker:

[◀, ▶] → [CANCEL] (on the remote control).

To mark another position: [◀, ▶] → [ENTER]

RAM

To mark the eleventh point and beyond

1. Use [◀, ▶] to select the marker pin icon.



2. Use [▲, ▼] to select "11-20".

You can select the next group when the current group is full.

- This feature doesn't work while using a play list.
- The markers are ordered by time. This means that the marker numbers can change when you add and erase markers.
- You can clear existing markers, but they are restored when you open the disc lid or switch the unit to standby.

Note

- This feature doesn't work during program and random play.
- Markers you add clear when you open the disc lid or switch the unit to standby.

Increasing your enjoyment of movies

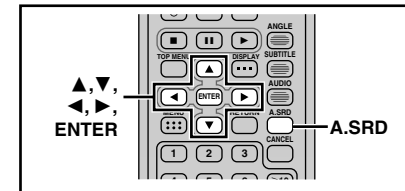

Advanced Surround

Remote control only

RAM DVD-V VCD (2-channel or over only)

Enjoy a surround-like effect with 2 speakers (SP) (on other equipment) or headphones (HP). If the disc has surround effects, the effect is broadened and sound seems to come from virtual speakers on either side.

Preparation

Turn off the surround effects on the other equipment.

Press [A.SRD].

Each time you press the button:

e.g. SP



1 (Natural) → 2 (Emphasized) → OFF (Cancel)

DVD-PS3



To change the mode

[◀] → [▲, ▼] to select "SP" or "HP".

Optimum seating position

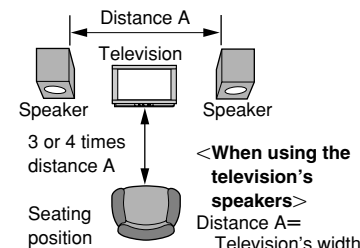

Note

- Turn Advanced Surround off if it causes distortion.
- **DVD-LS5** The speaker on this unit will not produce any discernable effect.

Increasing your enjoyment of movies

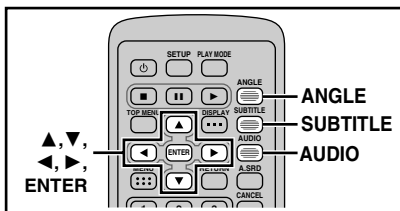

Changing soundtracks, subtitle languages and angles

Remote control only

Some discs have multiple soundtracks, subtitle languages and camera angles, and you can change these during play.

- “-” or “—” is displayed instead of the language number in circumstances such as when no language is recorded on the disc.

VCD (SVCD only)

Soundtrack and subtitle numbers may change even if corresponding soundtracks are not recorded.

Soundtracks

RAM DVD-A DVD-V VCD

During play

Press [AUDIO].

DVD-V

The number changes each time you press the button.



DVD-A

Soundtrack playing



Soundtrack selected

RAM VCD

Each time you press the button:



- You can also use this button to turn the vocals on and off on karaoke discs. Read the disc's instructions for details.
- Play restarts from the beginning of the soundtrack when playing DVD-Audio and DVD-RAM soundtracks that are accompanied by still pictures.
- Even if a second soundtrack isn't recorded on a DVD-Audio, two soundtrack numbers will normally be shown when you press [AUDIO]. The soundtrack currently playing is number 1.
- Refer to **B** on page 29 for audio signal type details.

Subtitles

DVD-A (Moving picture part) DVD-V

VCD (SVCD only):

You can change the subtitle number and turn the subtitles on and off.

RAM: You can turn the subtitles on and off.

During play

Press [SUBTITLE].

The number changes each time you press the button.



- In some cases, the subtitle language is not changed to the selected one immediately.

To clear/display the subtitles

1. Press [SUBTITLE].
2. Press [▶]. (DVD-A DVD-V VCD)
3. Press [▲, ▼] to select “ON” or “OFF”.

Changing the position and brightness of the subtitles

DVD-A DVD-V

1. While the subtitle icon is on the screen, use [◀, ▶] to highlight “Subtitle Position” or “Subtitle Brightness”.
2. Use [▲, ▼] to adjust.



- Adjust position between 0 and -60 in 2 unit steps.
- For brightness, select “Auto” so the brightness adjusts automatically against the background, or a level between 0 and -9.

Angles

DVD-A DVD-V

During play

Press [ANGLE].

The number changes each time you press the button.

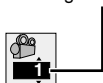

Changing the monitor settings DVD-LS5

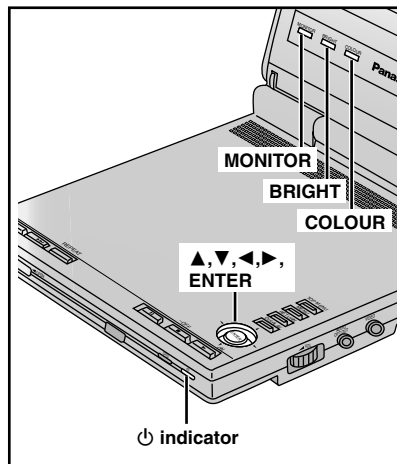

Main unit only

Adjusting colour intensity

- 1 Press [COLOUR].
- 2 Use [◀, ▶] to adjust the colour saturation and press [ENTER].
-5: decrease ←→ 5: increase

Adjusting the brightness

- 1 Press [BRIGHT].
- 2 Use [◀, ▶] to adjust the brightness and press [ENTER].
-5: darker ←→ 5: lighter
Power consumption increases with the level of brightness.

Changing the size of the picture

Select how to show 4:3-aspect pictures on the LCD.

Press [MONITOR].

Each time you press the button:

NORMAL → FULL → ZOOM
← OFF (no picture) ←

The picture mode and size

The picture shown on the LCD depends on the mode and the size recorded on the disc (→ below).

- If you are not using the LCD on this unit, select “OFF” (no picture) to conserve power (The [⏻] indicator flashes.).
- The LCD turns off if you close it.
- **Horizontal lines may appear in the picture when the mode is switched to “ZOOM”, but this is not an indication of malfunction.**
- “NORMAL” is the best setting to show 16:9-aspect pictures.

Mode \ Disc	NORMAL	FULL Stretched horizontally.	ZOOM Stretched vertically and horizontally.
4:3			
4:3 Letterbox			

Note

These changes are effective only for this unit's LCD. Make changes to the television's settings if you have connected one.

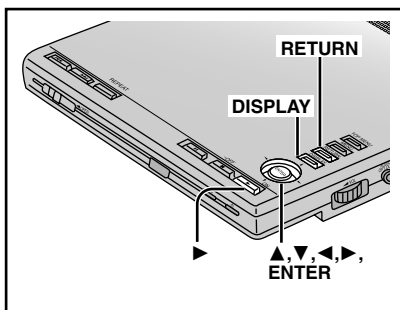

GUI (Graphical User Interface) screens contain information about the disc or unit. These menus allow you to perform operations by changing this information.

Common procedures

1 Press [DISPLAY].

Each time you press the button:

Disc information → Progress indicator
(⇒ page 29) (⇒ right)

Original display ← Unit information
(⇒ page 30)

2 [Unit information only]

While the leftmost icon is highlighted
Use [▲, ▼] to select the menu.

Each time you use the cursor jockey:

Play menu ↔ Picture menu
↕
Display menu ↔ Audio menu

3 Use [◀, ▶] to select the item.

4 Use [▲, ▼] to select the setting.

- Items with “▲” or “▼” above and below can be changed by [▲, ▼].
- Press [ENTER] if the setting does not change after using [▲, ▼].
- Some items require different operations. Read the explanations on the following pages.

For your reference

- Depending on the condition of the unit (playing, stopped, etc.) and the type of software, there are some items you cannot select or change.
- When numbers are displayed (e.g. title No.), the numbered buttons (remote control) are also effective for setting. After entering numbers, press [ENTER] to register the setting.

To clear the icons

Press [RETURN] until they clear.

To change the position of the icons

1. Use [◀, ▶] to select the Bar position
2. Use [▲, ▼] to move the icons. (There are 5 positions.)

Progress indicator

Indicates how far you have played through an item.

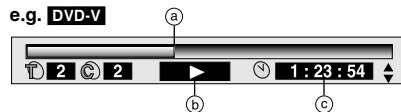

- a **Current position**
- b **Condition—play, pause, or slow/search**
- c **Changing the time display**
RAM DVD-A DVD-V VCD CD
• Use [▲, ▼] to show the elapsed play time or remaining time.
Elapsed play time
VCD (SVCD only) WMA MP3
For display only, cannot be changed.

Changing play speed

- DVD-A (Moving picture part) DVD-V (Dolby Digital only)
- You can slow down or speed up play. Use [◀] (slower) or [▶] (faster). There are five speeds:
×0.8 ↔ ×0.9 ↔ ×1.0 (normal speed) ↔ ×1.2 ↔ ×1.4
- After you change the speed:
– Multi-channel audio will be output in stereo.
– You cannot use Advanced Surround.
– Digital output switches to PCM.
– Sound is stereo as long as “×1.0” is orange.

To return to normal play

Press [▶] (Play).

Disc information

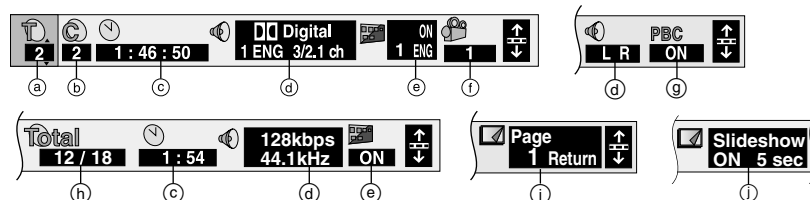

- a **PG: Program number** RAM
PL: Playlist number RAM
T: Title number DVD-V
T: Track number VCD CD
G: Group number
DVD-A WMA MP3 JPEG
- b **C: Chapter number** DVD-V
T: Track number DVD-A WMA MP3
P: Picture number JPEG
- c **Time** RAM DVD-A DVD-V VCD CD
• Use [▲, ▼] to show the elapsed play time or remaining time.
DVD-A VCD CD
→ Elapsed play time
↓
Remaining time for the track
↓
Remaining time for the disc/group
RAM DVD-A DVD-V

- Select a position to start play by specifying a time with the numbered buttons and press [ENTER].
- Elapsed play time**
VCD (SVCD only) WMA MP3
For display only, cannot be changed.
- e **Soundtrack language**
(See [A] right for language abbreviations.)
Audio signal type
(See [B] right for details.)
Audio Mode (⇒ page 26, Soundtracks)
Karaoke vocal on/off (Karaoke DVD only)
DVD-V
Solo: OFF or ON
Duet: OFF, V1+V2, V1 or V2
Current bitrate WMA MP3
Current sampling frequency WMA MP3
Subtitle language
(See [A] right for language abbreviations.)
Subtitles on/off
RAM DVD-A DVD-V VCD (SVCD only)
ON ↔ OFF
Track information on/off
WMA MP3 CD (CD text only)
ON ↔ OFF
Picture information JPEG
Date ↔ Full ↔ OFF

- f **Angle number** (⇒ page 26)
- g **Menu play** VCD
For display only, cannot be changed. (⇒ page 35, Glossary—Playback control)
- h **Track/picture number in disc**
Total number of tracks/pictures on disc
WMA MP3 JPEG
- i **Still picture number** DVD-A
Selected picture is shown during play.
• When “Return” is displayed
Select “Return” and press [ENTER] to return to the preset page (different depending on the disc).
- j **Slideshow setting** JPEG
ON ↔ OFF
Slideshow timing JPEG
0 sec–30 sec
Slideshow DVD-A
For display only, cannot be changed.

A Audio/Subtitle language

ENG: English	POR: Portuguese
FRA: French	RUS: Russian
DEU: German	JPN: Japanese
ITA: Italian	CHI: Chinese
ESP: Spanish	KOR: Korean
NLD: Dutch	MAL: Malay
SVE: Swedish	VIE: Vietnamese
NOR: Norwegian	THA: Thai
DAN: Danish	*: Others

B Signal type/data

LPCM/PPCM/Digital/DTS/MPEG:
Signal type
k (kHz): Sampling frequency
b (bit): Number of bits
ch (channel): Number of channels
e.g.: 3/2_1ch
L: Low frequency effect (not displayed if there is no signal)
0: No surround
1: Mono surround
2: Stereo surround (left/right)
1: Center
2: Front left+Front right
3: Front left+Front right+Center

Unit information

Play menu

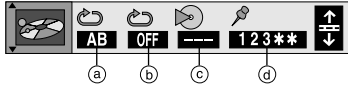

- a **A-B Repeat** (⇒ page 24)
 - b **Repeat Mode** (⇒ page 24)
- RAM DVD-A DVD-V VCD CD WMA MP3**
 (When the elapsed play time is displayed)
JPEG

RAM PG: Program
 A: All
 S: Scene #1
 PL: Playlist #1
 OFF: Off

DVD-A WMA MP3
 T: Track
 G: Group #2
 OFF: Off

DVD-V VCD CD JPEG
 C: Chapter T: Track G: Group
 T: Title #2 A: All OFF: Off
 OFF: Off OFF: Off

*1 During play list play.
 *2 "A(All)" during all group, program and random play.

- c **Play mode display**
DVD-A DVD-V VCD CD WMA MP3
 ----: Normal play
 PGM: Program play
 RND: Random play
 ALL: All group play (**DVD-A**)

- d **Marker** (⇒ page 25)

Picture menu



Picture Mode
RAM DVD-A DVD-V VCD JPEG
 N: Normal mode
 C1: Mellows images and enhances detail in dark scenes
 C2: Sharpens images and enhances detail in dark scenes

Audio menu



- a **Advanced Surround** (⇒ page 25)
- b **Dialogue Enhancer DVD-V**
 (Dolby Digital/DTS, 3-channel or over only)
 ON ↔ OFF
 The volume of the dialogue from the center channel is raised when you select "ON".

Display menu

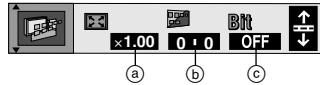

- a **Zoom RAM DVD-A** (Moving picture part)
DVD-V VCD
 Change the zoom ratio so the picture expands to the optimum size to fill the screen.

To select the aspect ratio:



To make fine adjustments to the zoom ratio: [▲, ▼]
 ×1.00 – ×2.00

- b **Subtitle Position/Brightness** (⇒ page 26)
- c **Bitrate Display RAM DVD-A DVD-V VCD**
 ON ↔ OFF
 Displays the bitrate (approximate values) and type of picture (I/P/B ⇒ page 35, Glossary)
During play: Shows the average bit rate of the video being played
While paused: Shows the data volume of the frame

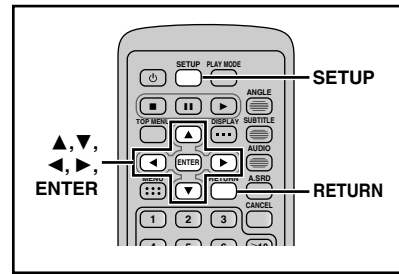

Common procedures

See pages 32 and 33 for menu and option details.

- 1 Press [SETUP] to show the menus.

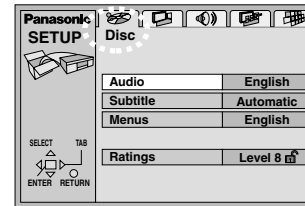

- 2 Press [◀, ▶] to select the menu's tab.
 The screen changes to display the menu.
 Disc ↔ Video ↔ Audio
 Others ↔ Display
- 3 Press [▲, ▼] to select the item and press [ENTER].
- 4 Press [▲, ▼, ▶, ◀] to select the option and press [ENTER].
 The screen now shows the menu again.

To return to the previous screen
 Press [RETURN].

When you are finished
 Press [SETUP].

For your reference
 Press [MENU] on the main unit to access the SETUP menus when a disc is not loaded.



Language code list



6566: Abkhazian	7074: Fiji	7678: Lingala	8373: Singhalese
6565: Afar	7073: Finnish	7684: Lithuanian	8375: Slovak
6570: Afrikaans	7082: French	7775: Macedonian	8376: Slovenian
8381: Albanian	7089: Frisian	7771: Malagasy	8379: Somali
6577: Ameharic	7176: Galician	7783: Malay	6983: Spanish
6582: Arabic	7565: Georgian	7776: Malayalam	8385: Sundanese
7289: Armenian	6869: German	7784: Maltese	8387: Swahili
6583: Assamese	6976: Greek	7773: Maori	8386: Swedish
6588: Aymara	7576: Greenlandic	7782: Marathi	8476: Tagalog
6590: Azerbaijani	7178: Guarani	7779: Moldavian	8471: Tajik
6665: Bashkir	7185: Gujarati	7778: Mongolian	8465: Tamil
6985: Basque	7265: Hausa	7865: Nauru	8484: Tatar
6678: Bengali; Bangla	7387: Hebrew	7869: Nepali	8469: Telugu
6890: Bhutani	7273: Hindi	7879: Norwegian	8472: Thai
6672: Bihari	7285: Hungarian	7982: Oriya	6679: Tibetan
6682: Breton	7383: Icelandic	8083: Pashto, Pushto	8473: Tigrinya
6671: Bulgarian	7378: Indonesian	7065: Persian	8479: Tonga
7789: Burmese	7365: Interlingua	8076: Polish	8482: Turkish
6669: Byelorussian	7165: Irish	8084: Portuguese	8475: Turkmen
7577: Cambodian	7384: Italian	8065: Punjabi	8487: Twi
6765: Catalan	7465: Japanese	8185: Quechua	8575: Ukrainian
9072: Chinese	7487: Javanese	8277: Rhaeto-Romance	8582: Urdu
6779: Corsican	7578: Kannada	8279: Romanian	8590: Uzbek
7282: Croatian	7583: Kashmiri	8285: Russian	8673: Vietnamese
6783: Czech	7575: Kazakh	8377: Samoan	8679: Volapük
6865: Danish	7589: Kirghiz	8365: Sanskrit	6789: Welsh
7876: Dutch	7579: Korean	7168: Scots Gaelic	8779: Wolof
6978: English	7585: Kurdish	8382: Serbian	8872: Xhosa
6979: Esperanto	7679: Laotian	8372: Serbo-Croatian	7473: Yiddish
6984: Estonian	7665: Latin	8378: Shona	8979: Yoruba
7079: Faroese	7686: Latvian, Lettish	8368: Sindhi	9085: Zulu

Changing settings

This chart shows the settings for this unit. Change the settings to suit your preference and to suit the unit to the environment in which it is being used. These settings are retained in memory until they are changed, even the unit is turned off. See page 31 for operation.

● Underlined items are the factory presets.

Menus	Items
 Disc	<p>Audio Choose the preferred audio language. <u>English</u> Original*¹ Other**²***³</p> <p>Subtitle Choose the preferred subtitle language. <u>Automatic</u>² English Other**²***³</p> <p>Menus Choose the preferred language for disc menus. <u>English</u> Other**²***³</p> <p>Language Options For the United Kingdom, Continental Europe, Russia, Australia and N.Z. French German Italian Spanish Portuguese Swedish Dutch For Asia French Spanish</p>
	<p>Ratings Set a ratings level to limit DVD-Video play. <u>8 No Limit</u> 1 to 7: Prohibits play of DVD-Video with corresponding ratings recorded on them. 0 Lock All</p> <p>Entering a password The password screen is shown when you select levels 0 to 7. 1. Input a 4-digit password with the numbered buttons. ● If you enter a wrong number, press [CANCEL] to erase it. 2. Press [ENTER]. ● Do not forget your password. 3. Press [ENTER] to confirm the 4 digits. ● Now, when you insert a DVD-Video that exceeds the ratings limit you set, a message appears on the screen. Follow the on-screen instructions.</p> <p>--- *¹ The original language of each disc is selected. *² If the language selected for "Audio" is not available, subtitles of that language will automatically appear if available on that disc. *³ Input a code number with the numbered buttons (⇒ page 31).</p>
 Video	<p>TV Aspect (⇒ page 15) Choose the setting to suit your television and preference. 4:3 Pan&Scan*¹ 4:3 Letterbox <u>16:9</u></p> <p>Still Mode Specify the type of picture shown when paused. <u>Automatic</u> Field Frame</p> <p>NTSC Disc Output Choose whether PAL60 or NTSC signal is output during playback of NTSC discs (⇒ page 8). PAL60: when connected to a PAL television. NTSC*²: when connected to an NTSC television.</p> <p>--- *¹ <u>DVD-PS3</u> 4:3 Pan & Scan is the factory preset. *² <u>DVD-PS3</u> For Asia NTSC is the factory preset.</p>
	<p>Audio  PCM Down Conversion (Digital connection) Select how to output audio with a sampling frequency of 96 kHz or 88.2 kHz. Select "Yes" if the equipment you connect cannot process signals with a sampling frequency of 96 kHz or 88.2 kHz. <u>No</u>: Output as 96 kHz or 88.2 kHz. <u>Yes</u>: Converted to 48 kHz or 44.1 kHz. ● Signals are converted to either 48 kHz or 44.1 kHz despite the above settings if the signals have a sampling frequency of over 96 kHz, or the disc has copy protection. ● Some equipment cannot handle sampling frequencies of 88.2 kHz, even if they can handle 96 kHz. Read your equipment's operating instructions for details.</p>

Menus	Items
 Audio	<p>Dolby Digital (Digital connection) Select "Bitstream" if the equipment you connect can decode the signal. <u>Bitstream</u> PCM</p> <p>DTS Digital Surround (Digital connection) Select "Bitstream" if the equipment you connect can decode the signal. <u>PCM</u> Bitstream</p> <p>MPEG*¹ (Digital connection) Select "Bitstream" if the equipment you connect can decode the signal. <u>PCM</u> Bitstream</p> <p>IMPORTANT (Dolby Digital/DTS Digital Surround/MPEG*¹) If the equipment cannot decode the signal, the setting must be changed to PCM. If not, signals the equipment cannot process will be output, causing high levels of noise which can damage your hearing and the speakers.</p> <p>Dynamic Range Compression (Dolby Digital Only) Change the dynamic range for late night viewing. <u>Off</u> On</p> <p>Audio during Search*² Choose whether to have sound during search. <u>On</u> Off</p> <p>--- *¹ For Asia MPEG is not available. *² Audio will be heard when playing some DVD-Audio despite the settings you make here.</p>
	<p>Display  Menu Language Choose the preferred language for these menus and the on-screen messages. For the United Kingdom, Continental Europe, Russia, Australia and N.Z. <u>English</u> Français Deutsch Italiano Español Português Svenska Nederlands For Asia <u>English</u> Français Español</p> <p>On-Screen Messages Choose whether to show on-screen messages or not. <u>On</u> Off</p>
<p>Others  HighMAT Play HighMAT discs as HighMAT discs, or as regular WMA/MP3/JPEG discs. <u>Enable</u>: Play HighMAT discs as HighMAT discs. Disable: Play HighMAT discs as regular WMA/MP3/JPEG discs.</p> <p>Mixed Disc-Audio & Stills Select the type of file played on discs containing both JPEG and WMA/MP3. <u>Audio (MP3/WMA)</u> Stills (JPEG)</p> <p>DVD-Video Mode Select how to play pictures contained on some DVD-Audio. The setting returns to "Off" when you remove the disc or turn the unit off. <u>Off</u>: DVD-Audio are played as DVD-Audio. <u>On</u>: You can play DVD-Video content on DVD-Audio.</p> <p>Demmo A demonstration of the unit's on-screen displays starts when you select "On". The demonstration stops and the setting reverts to "Off" when you press a button (<u>DVD-LS5</u> except [MONITOR], [BRIGHT], and [COLOUR]). <u>Off</u> On</p> <p>QUICK SETUP <u>DVD-PS3</u> (⇒ page 15) Answer questions to make basic settings. Yes <u>No</u></p>	

Using this unit with other equipment

The explanation in this section use DVD-LS5 as an example, but the same connections and the settings are possible with DVD-PS3.

Enjoying more powerful sound

Enjoy the powerful movie theater and hall-like sound available with multiple channel audio found on DVDs by connecting an amplifier and speakers.

Note

- The equipment connections described are examples.
- Peripheral equipment and optional cables sold separately unless otherwise indicated.
- Before connection, turn off all equipment and read the appropriate operating instructions.

A Digital connection

To enjoy multi-channel surround sound

Connect an amplifier with a built-in decoder or a decoder-amplifier combination.

- Change the settings in "Audio" (⇒ pages 32-33).

To enjoy stereo or Dolby Pro Logic

Connect a digital amplifier or system component.

- Change the settings in "Audio" (⇒ pages 32-33).

Note

- You can only use DTS Digital Surround decoders that are compatible with DVD.
- Even if using this connection, output will be only 2 channels. **DVD-A**

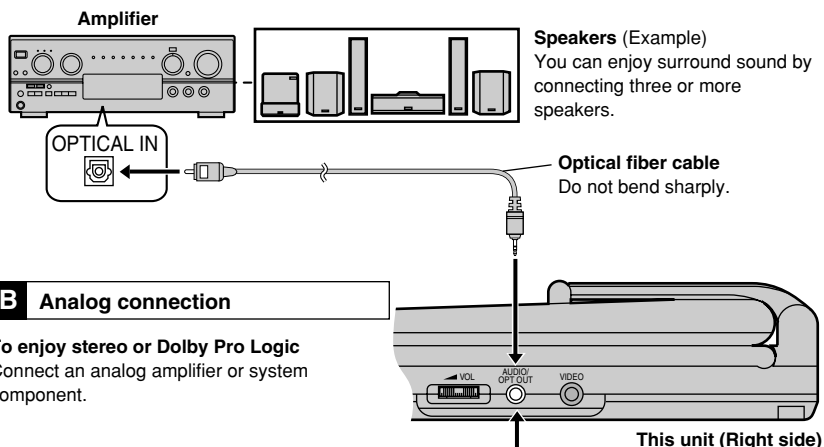

B Analog connection

To enjoy stereo or Dolby Pro Logic

Connect an analog amplifier or system component.

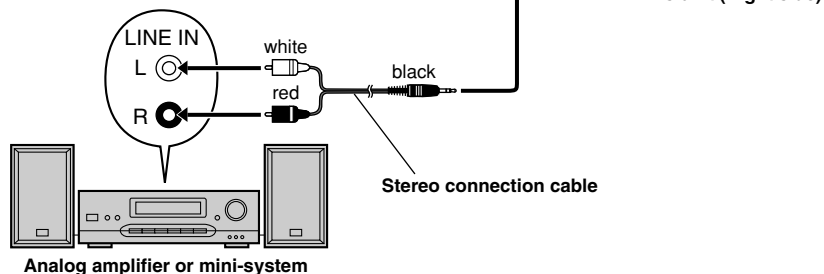

Recording to digital recording equipment or cassette tapes

• Digital recording

You can record the digital signal directly to digital recording equipment.

Connect the recording equipment with an optical fiber cable (⇒ **A** page 34).

Note

- With DVD, the following conditions must be met: ① the disc doesn't have protection preventing digital recording, and ② the recording equipment can handle signals with a sampling frequency of 48 kHz.
 - You cannot record WMA/MP3.
- When recording DVDs, make the following settings.
- Advanced Surround: OFF (⇒ page 25)
 - PCM Down Conversion: Yes (⇒ page 32)
 - Dolby Digital/DTS Digital Surround/MPEG*: PCM (⇒ page 33)
- * For Asia MPEG is not available.

• Analog recording

You can record to a cassette deck or other recording equipment. There are no limitations on recording analog signals as there are with digital signals.

Connect the recording equipment with the stereo connection cable (⇒ **B** page 34).

Glossary

Bitstream

The digital form of multi-channel data (e.g., 5.1 channel) before decoding.

Decoder

A decoder restores the coded audio signals on DVDs to normal. This is called decoding.

Dolby Digital

This is a method of coding digital signals developed by Dolby Laboratories. Apart from stereo (2-channel) audio, these signals can also be multi-channel audio. A large amount of audio information can be recorded on the disc using this method.

Dolby Pro Logic

A surround system where a 4-channel audio track is recorded as 2 channels and then is restored to 4 channels for play. The surround channel is monaural and can reproduce up to 7 kHz.

DTS (Digital Theater Systems)

This surround system is used in many movie theaters around the world. There is good separation between the channels, so realistic sound effects are possible.

Dynamic range

Dynamic range is the difference between the lowest level of sound that can be heard above the noise of the equipment and the highest level of sound before distortion occurs.

Frame still and field still

Frames are the still pictures that make moving pictures. About thirty are shown each second. A frame still may appear blurred but overall quality is high.

Two fields appear alternately to make up one frame. A field still is not blurred but picture quality is lower.

I/P/B

MPEG 2, the video compression standard adopted for use with DVD-Video, codes frames using these 3 picture types.

I: Intra coded picture

This picture has the best quality and is the best to use when adjusting the picture.

P: Predictive coded picture

This picture is calculated based on past I or P-pictures.

B: Bidirectionally-predictive coded picture

This picture is calculated by comparing past and future I and P-pictures so it has the lowest volume of information.

Linear PCM (pulse code modulation)

These are uncompressed digital signals, similar to those found on CDs.

Playback control (PBC)

If a Video CD has playback control, you can select scenes and information with menus.

Troubleshooting Guide

Before requesting service, make the following checks. If you are in doubt about some of the check points, or if the remedies indicated in the chart do not solve the problem, consult your dealer for instructions. Reference pages are shown as black circled numbers ⑫.

Power

No power.	<ul style="list-style-type: none"> • Check connections to the AC adaptor or battery pack. ⑫ • You cannot turn on the unit with the remote control if the unit is powered by the battery pack.
Unit turns off automatically. Unit doesn't work when powered by battery.	<ul style="list-style-type: none"> • The unit turns off after it has been stopped for about 15 minutes (5 minutes when the unit is powered by the battery pack) to conserve power. Turn the unit on again. • The unit and battery pack have protection circuitry that activate if they become too hot or too cold. They will not work if this occurs. Use the unit and battery pack between 5 °C and 35 °C.
Cannot charge or the [CHG] indicator fails to light.	<ul style="list-style-type: none"> • The battery pack can only be recharged when the unit is off. • The charging time increases when the temperature is too hot or too cold, and charging may not be possible under some circumstances. • Check connection to the AC adaptor. ⑫
Play time dramatically reduces after recharging.	<ul style="list-style-type: none"> • The battery pack has reached the end of its service life (it can be recharged about 300 times).

Operation

No response when buttons are pressed.	<ul style="list-style-type: none"> • Some discs prohibit certain operations. • [DVD-PS3] Release the hold mode. ⑮ • If there is no response at all, the unit may have been affected by lightning or static electricity. Try turning the unit off and on again. Alternatively, turn the unit off, disconnect the power source (AC or battery pack) reconnect the power and turn the unit on again.
Play fails to start or stops soon after starting.	<ul style="list-style-type: none"> • Condensation may have formed in the unit. Wait 1 or 2 hours for it to clear. • This unit cannot play discs other than those specified. ⑧ • Clean the disc. ⑨ • Ensure the disc is inserted correctly. ⑮ • Check that the disc has something recorded on it.
No operation with remote control.	<ul style="list-style-type: none"> • Check that the battery is inserted correctly. ① • Replace the battery if it is drained. ① • Aim the remote control at the remote control signal sensor. ①
The audio soundtrack or subtitle language cannot be changed. Subtitles not shown.	<ul style="list-style-type: none"> • This function is dependent on software availability. • Some DVDs require you to change the languages through menus. • This function is dependent on software availability. • Turn the subtitles on. ⑳ • Subtitle position is wrong. Adjust the position. ㉔
Angles cannot be changed.	<ul style="list-style-type: none"> • This function is dependent on software availability. • There may be parts of multi-angle DVDs where different angles are not recorded.
You have forgotten your ratings password. You want to reset the unit to the factory settings.	<ul style="list-style-type: none"> • Do the following to reset the unit to its original factory settings. While the unit is stopped, press and hold [II], [◀◀] (backward), and [▶, ON] on the main unit for about 3 seconds until the message "Initialized" disappears, then turn the unit off.

Sound

There is a lot of noise. [DVD-LS5] No sound from the unit's speaker.	<ul style="list-style-type: none"> • Move unit away from mobile phones. • The speaker is off if the LCD is closed or headphones are connected. • Turn up the volume. ⑮
No sound from other speakers. Distorted sound.	<ul style="list-style-type: none"> • Check all connections and settings. ⑮, ㉒-㉔ • Check input mode of the other equipment. • Advanced Surround may cause distortion with some discs. Turn Advanced Surround off if this occurs. ㉔ • Some DVD-Audio specify the number of channels to be played and prohibit down-mixing to 2 channels. Read the disc's instructions for details. • Press [▶] (Play) to restore normal play after changing the speed. ㉔ • Noise may occur when playing WMA files.
Sound effects do not work.	<ul style="list-style-type: none"> • Dialogue Enhancer and Advanced Surround do not work when the unit is outputting bitstream signals. • Advanced Surround does not work if you have changed the play speed. ㉔

Picture

[DVD-LS5] The LCD is dark.	<ul style="list-style-type: none"> • Adjust the brightness. ㉗
Picture distorted.	<ul style="list-style-type: none"> • Some disruption is normal during SEARCH.
Menus not displayed correctly.	<ul style="list-style-type: none"> • Restore the zoom ratio to ×1.00. ㉔ • Set the subtitle position to 0. ㉔
[DVD-LS5] No picture on the LCD	<ul style="list-style-type: none"> • Select a picture mode other than "OFF" (no picture). ㉗
Picture doesn't appear on the television (or the size of the picture seems wrong).	<ul style="list-style-type: none"> • Check connections. ⑭ • Check that the television is on. • Check that the input mode on the television is correct. • Check the settings in "Video—TV Aspect". ⑮ • [DVD-PS3] Turn Audio Only Player off. ㉒ • Turn off the zooming feature of your television if you are using variable Zoom. ㉔ • Ensure that the unit is connected directly to the television, and is not connected through a video cassette recorder. ⑭
[DVD-LS5] The LCD is constructed with precision technology so 99.99 % of the pixels are active, but of the remaining of 0.01 %, there are pixels that may be black or emit light constantly. This phenomenon is not a malfunction.	<ul style="list-style-type: none"> • The LCD is constructed with precision technology so 99.99 % of the pixels are active, but of the remaining of 0.01 %, there are pixels that may be black or emit light constantly. This phenomenon is not a malfunction.
The SETUP menus and other screens shown on the television are displayed incorrectly. Colours appear faded.	<ul style="list-style-type: none"> • The unit and television are using different video systems. Use a multi-system or PAL television. • [DVD-PS3] for Asia Use a multi-system or NTSC television.

Indicator

GUI screens are cut off.	<ul style="list-style-type: none"> Use [▲, ▼] while the Bar position icon is highlighted to move them down. 28
No On-Screen messages.	<ul style="list-style-type: none"> Go to the Display menu in the SETUP screen, and select "On" for "On-Screen Messages". 33
"Check the disc."	<ul style="list-style-type: none"> Is the disc dirty ? 9 Has the disc (DVD-R) been finalized ? 8
"■■■■ ERROR 01"	<ul style="list-style-type: none"> A problem has occurred with the battery pack. Consult your dealer.
"■■■■ ERROR 02"	<ul style="list-style-type: none"> The battery pack has been recharging for 12 hours but has failed to recharge for some reason. Recharge again.
"■■■■ ERROR 03"	<ul style="list-style-type: none"> You are recharging in a location that is too hot or too cold. Recharge at normal temperature.
"H □□" □□ stands for a number.	<ul style="list-style-type: none"> Trouble has occurred. The number appearing after H depends on the problem. Turn the unit off and on again. Alternatively, turn the unit off, disconnect the power source (AC or battery pack) reconnect the power and turn the unit on again. If the service numbers fail to clear, note the service number and contact a qualified service person.

[⏻] and [CHG] indicators

The [⏻] indicator flashes rapidly.	<ul style="list-style-type: none"> The unit has malfunctioned. Consult your dealer. [DVD-PS3] Release the hold mode. 16
[DVD-LS5] The [⏻] indicator flashes slowly.	<ul style="list-style-type: none"> The unit is on and the LCD is closed or the display mode is set to "OFF" (no picture). Turn the unit off when you have finished.
The [CHG] indicator flashes rapidly.	<ul style="list-style-type: none"> There is a problem with the battery pack. Turn the unit on and check the message indicator. (➡ above)
The [CHG] indicator flashes slowly.	<ul style="list-style-type: none"> Battery pack charge is low. The unit will turn off automatically after a few minutes. 18

Note

The following do not indicate malfunction.

- Sound from the AC adaptor during recharging.
- The battery pack warming up when recharging or during use.

Maintenance

■ To clean this unit, wipe with a soft, dry cloth.

- [DVD-LS5] Use eyeglass cleaner to remove stubborn dirt from the LCD.
- Never use alcohol, paint thinner or benzine to clean this unit.

■ Maintenance of the lens

- Remove dust carefully with an air blower for camera lenses (optional).
Recommended product:
Lens cleaner kit (SZZP1038C)
(Available from Panasonic dealers.)
- Be careful not to touch the lens with your fingers.

Specifications

Operating temperature range:

+5 to +35 °C

Operating humidity range:

5–90 % RH (no condensation)

Discs played:

DVD-RAM (DVD-VR format)
DVD-Video
DVD-Audio
Music CD [CD-DA (CD-TEXT compatible)]
Video CD
CD-R/CD-RW [CD-DA (CD-TEXT compatible),
Video CD, MP3, WMA, JPEG,
HighMAT Level 2 (Audio and Image)]
DVD-R (finalized as DVD-Video)

Signal system:

PAL/PAL60 (NTSC) selectable

[DVD-PS3] For Asia PAL/NTSC (PAL60) selectable

LCD screen [DVD-LS5] :

5" α-Si, TFT wide-screen LCD

Composite-video output:

Output level: 1 Vp-p (75 Ω)
Output terminal: Mini-jack
Number of terminals: 1 system

S-video output:

Y output level: 1 Vp-p (75 Ω)
C output level: 0.3 Vp-p (75 Ω)
Output terminal: Mini-jack
Number of terminals: 1 system
(also used for composite-video output)

Audio output:

Output level: 1.5 Vrms (1 kHz, 0 dB, 10 kΩ)
Output terminal: Stereo mini-jack
Number of terminals: 1 system

Audio performance:

- Frequency response:
 - DVD (linear audio):
4 Hz–22 kHz (48 kHz sampling)
4 Hz–44 kHz (96 kHz sampling)
 - DVD Audio:
4 Hz–88 kHz (192 kHz sampling)
 - CD audio: 4 Hz–20 kHz
- S/N ratio:
 - CD audio: 115 dB
- Dynamic range:
 - DVD (linear audio): 98 dB
 - CD audio: 97 dB
- Total harmonic distortion:
 - CD audio: 0.008 %

Digital audio output:

Optical digital output: Mini optical terminal
Number of terminals: 1 system
(also used for audio output)

Pickup:

Wave length: 658 nm/790 nm
Laser power: CLASS 2/CLASS 1

NORSK

Pickup

Bølgelengde: 658 nm/790 nm
Laserstyrke: Ingen farlig stråling sendes ut
(med sikkerhets-beskyttelse)
KLASSE 2/KLASSE 1

Power supply:

DC 9 V (DC IN terminal)/
DC 7.2 V (Exclusive battery terminal)

Power consumption

(Using included AC adaptor):

[DVD-LS5] 12 W (Unit only: 8.5 W)

[DVD-PS3] 6 W (Unit only: 4 W)

Recharging 12 W

AC adaptor:

Power source: AC 100–240 V, 50/60 Hz

Power consumption: 20 W

DC output: 9 V, 1400 mA

Battery pack

CGR-H603 (lithium ion) [DVD-LS5]:

Voltage: 7.2 V

Capacity: 2000 mAh

Dimensions:

[DVD-LS5] 144 (W)×140 (D)×32.5* (H) mm
(excluding protrusions)
*28.7 mm at lowest point

[DVD-PS3] 144 (W)×140 (D)×20.2* (H) mm
(excluding protrusions)
*19.2 mm at lowest point

Mass:

[DVD-LS5] 566 g

[DVD-PS3] 310 g

Note

Specifications are subject to change without notice.

Mass and dimensions are approximate.

Power consumption in standby mode
(using included AC adaptor): 0.9 W

**CLASS 1
LASER PRODUCT**

**LUOKAN 1 LASERLAITE
KLASS 1 LASER APPARAT**

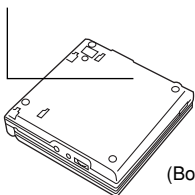

(Bottom of product)

CAUTION — VISIBLE AND INVISIBLE LASER RADIATION WHEN OPEN. AVOID EXPOSURE TO BEAM.
ATTENTION — RAYONNEMENT LASER VISIBLE ET INVISIBLE EN CAS D'OUVERTURE. EXPOSITION DANGEREUSE AU FAISCEAU.
VORSICHT — SICHTBARE UND UNSICHTBARE LASERSTRAHLUNG, WENN ABDECKUNG GEÖFFNET. NICHT DEM STRAHL AUSSETZEN.
ADVARSEL — SYNLIG OG USYNLIG LASERSTRÅLING VED ÅBNING. UNDGÅ UDSÆTTELSE FOR STRÅLING.
ADVARSEL — SYNLIG OG USYNLIG LASERSTRÅLING NÅR DEKSEL ÅPNES. UNNGÅ EKSPONERING FOR STRÅLEN.
VARNING — SYNLIG OCH OSYNLIG LASERSTRÅLNING NÅR DENNA DEL ÄR ÖPPNAD. STRÅLEN ÄR FARLIG.
VARO! — AVATTAESSA OLET ALLTIINA NÄKYVÄÄ JA NÄKYMÄTÖN LASERSÄTEILYLLE. ÄLÄ KATSO SÄTEESEEN.
注意 — 打开时有可见及不可见激光辐射。避免激光束照射。

(Bottom of product)
(Produktets underside)
(Tuotteen pohjassa)

Manufactured under license from Dolby Laboratories.
"Dolby" and the double-D symbol are trademarks of Dolby Laboratories.

MPEG Layer-3 audio decoding technology licensed from Fraunhofer IIS and Thomson multimedia.

Manufactured under license from Digital Theater Systems, Inc. US Pat. No. 5,451,942, 5,956,674, 5,974,380, 5,978,762 and other world-wide patents issued and pending. "DTS" and "DTS Digital Surround" are registered trademarks of Digital Theater Systems, Inc. Copyright 1996, 2000 Digital Theater Systems, Inc. All rights reserved.

This product incorporates copyright protection technology that is protected by method claims of certain U.S. patents and other intellectual property rights owned by Macrovision Corporation and other rights owners. Use of this copyright protection technology must be authorized by Macrovision Corporation, and is intended for home and other limited viewing uses only unless otherwise authorized by Macrovision Corporation. Reverse engineering or disassembly is prohibited.

Matsushita Electric Industrial Co., Ltd.
Web Site: <http://www.panasonic.co.jp/global/>

(En)

RQT7074-3B
F0603AT4114